

HOOX-LOC Base Corner Susan Assembly

Step1: Slide side panels into hook groove on face frame. Flush with top.

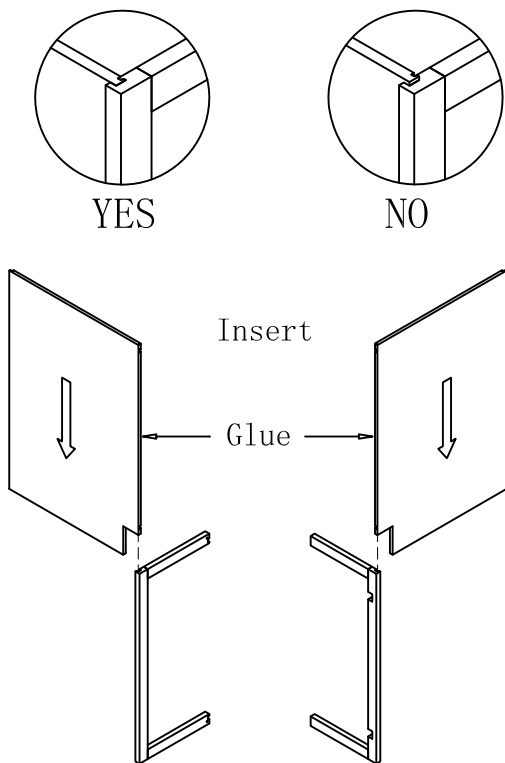

Step2: Slide top and bottom into hook groove on side panel with face frame without hinge notch.

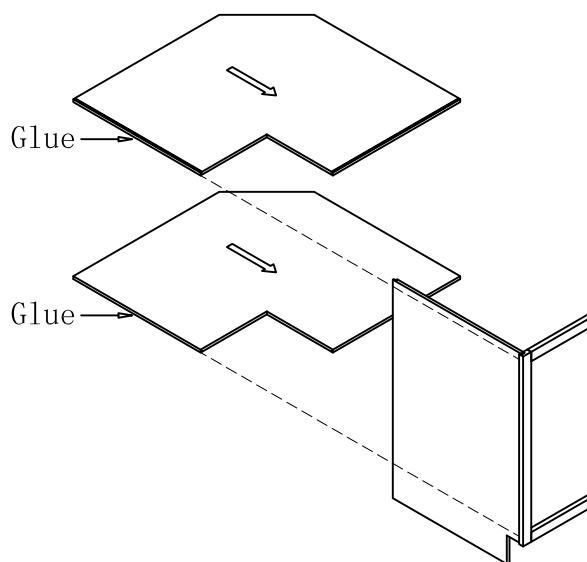

Step3: Slide side panel into hook groove on top and bottom. carefully slide face frame past each other. Install screw into face frame.

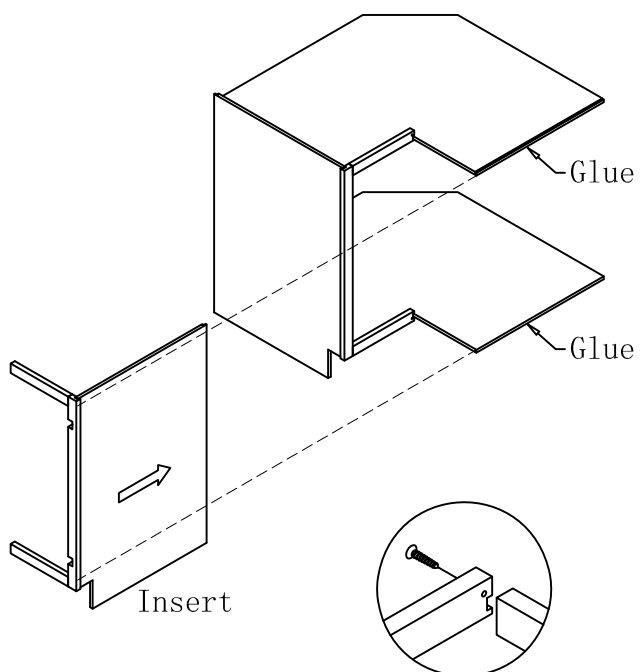

Step4: Install shelf.

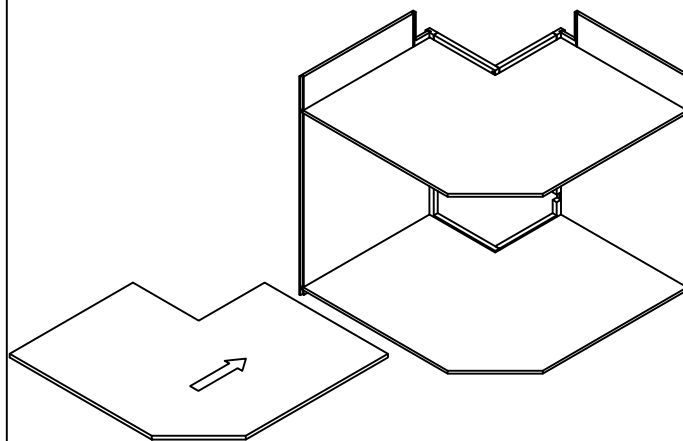

HOOX-LOC Base Corner Susan Assembly

Step5: Install back panels screw into place.

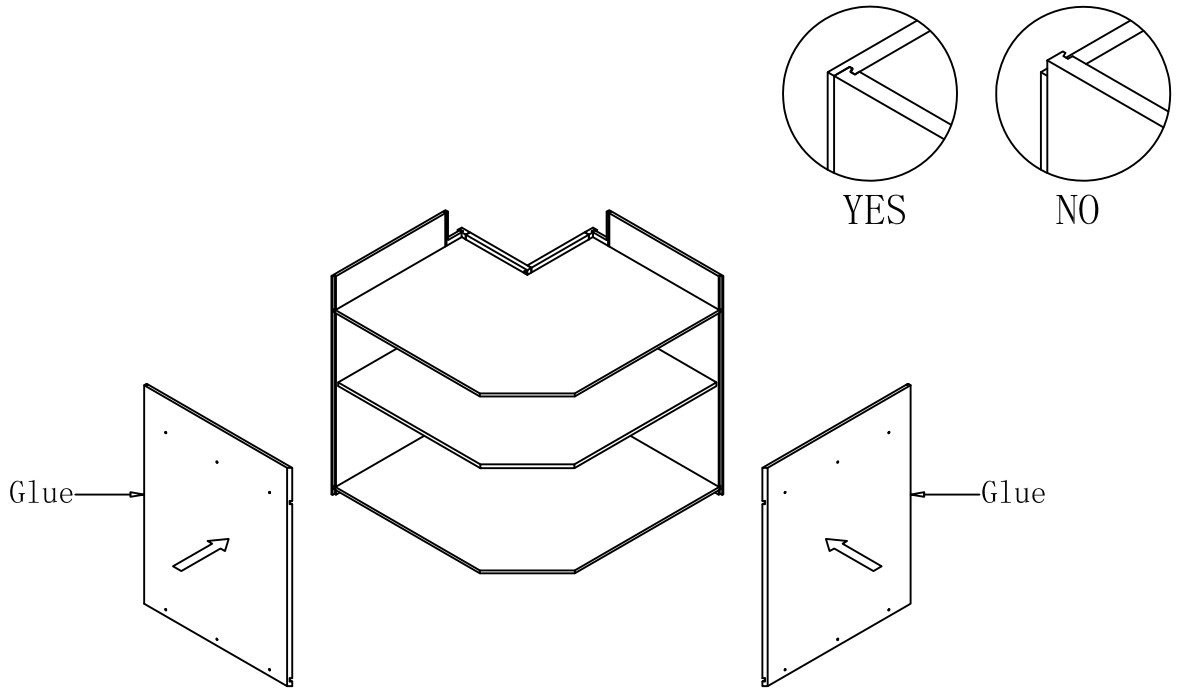

Step6: Install corner back locking everything together screw into place .

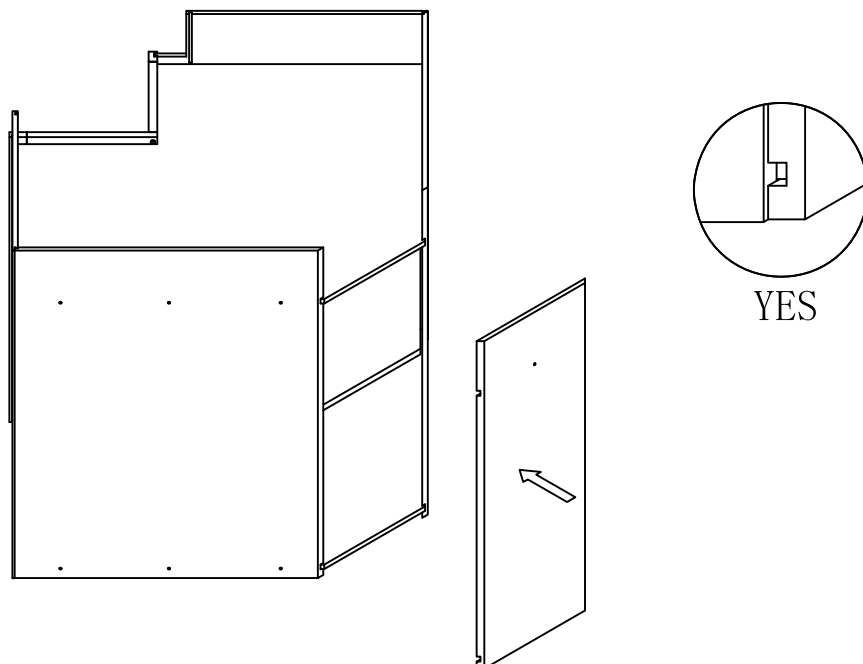

HOOVER-LOC Base Corner Susan Assembly

Step7:Toe kick assembly.

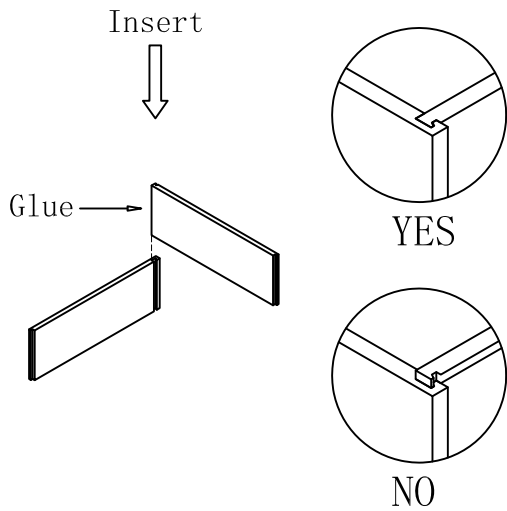

Step4:Install toe kick .

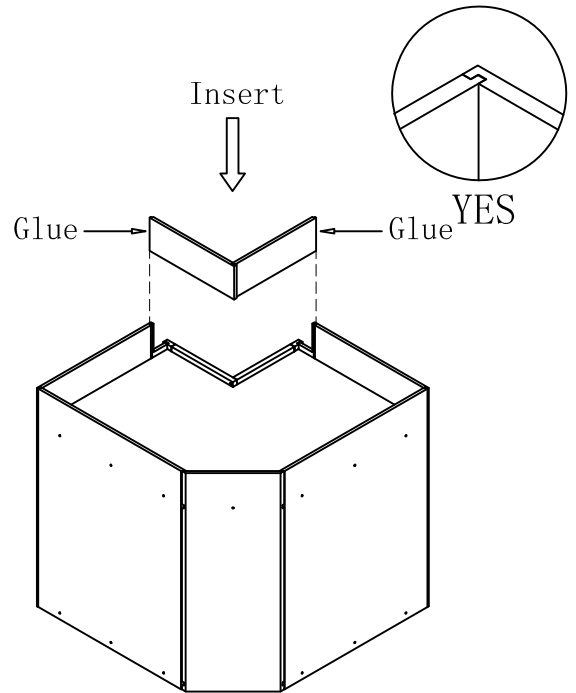

Step9:Install screws as show .

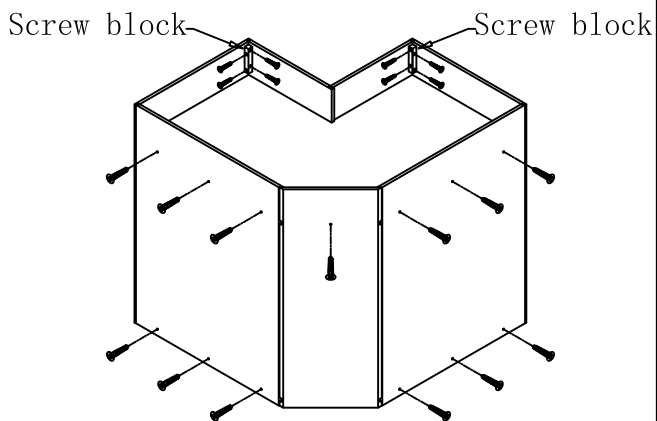

Step10:

- Clean any excess glue.
- Install and adjust doors.

